

# Individuelle Akzente



Jasna-See, Kranjska gora

Foto: 123rf

# elegant, edel und wertig

Eine Haustür verkörpert in ganz besonderer Weise die Kreativität des Hausbesitzers bei seiner ganz persönlichen Gestaltung des Eingangsbereiches seines Anwesens.

Deshalb wurde bei der Konzipierung des ISARHOLZ-Design -Aluminium-Haustürenprogramms neben den eleganten Profilformen und Alu-Füllungen, den schönen Accessoires, den Oberflächenfarben in RAL, Metallic- und Holzdekoren und dem Bedienungskomfort besonders auf die beispielhafte Vielfältigkeit individueller Gestaltungsmöglichkeiten Wert gelegt.

ISARHOLZ-Aluminium-Haustüren fördern mit Top Lösungen die Sicherheit Ihres Hauses.

ISARHOLZ-Aluminium-Haustüren stellen eine sinnvolle Kapitalanlage dar.

Mit dem Kauf einer ISARHOLZ-Design-Alu-Haustüren haben Sie sich für ein Markenprodukt der Spitzenklasse entschieden.

Attraktiv sind die einheitlichen Farbgestaltungen von ISARHOLZ-Aluminium-Haustüren mit Kunststoff/Alu- und Holz/Alu-Fenstern. Diese Kombination gibt Ihrer Immobilie eine architektonisch und optisch reizvolle Note.



# INHALT

## ALUMINIUM Haustüren Kollektion



### TREND AT

6 - 45

Diese Serie beinhaltet Modelle ohne Verglasungsrahmen und Ausführungen ohne Verglasung. Sie sind in ADS 75B.SI innen und außen flächenbündig und in den Systemen ADS 95.SI, ADS 95AK.SI und ADS 75.SI einseitig flügelüberdeckend oder beidseitig flügelüberdeckend erhältlich. Darüber hinaus wählen Sie zwischen Nuten und Applikationen außen oder beidseitig, sowie außenliegenden Ziergittern und LED-Leuchten.



### DELUXE AD

46 - 51

Diese Modelle zeichnen sich durch Gläser mit Edelstahl- und Aluminiumrahmen bzw. durch außen oder beidseitig angebrachten Applikationen aus. Sie sind in ADS 75B.SI innen und außen flächenbündig und in den Systemen ADS 95.SI, ADS 95AK.SI, ADS 75.SI einseitig flügelüberdeckend oder beidseitig flügelüberdeckend erhältlich. Darüber hinaus wählen Sie zwischen Nuten außen oder beidseitig und LED-Leuchten.



### MODERN AM

52 - 59

Bei den Ausführungen dieser Serie sind die Gläser von außen mit einem Aluminium-Verglasungsrahmen eingelassen. Modelle erhalten Sie in den Systemen ADS 95.SI, ADS 95AK.SI, ADS 75.SI und ADS 75B.SI. Darüber hinaus wählen Sie zwischen flügelüberdeckend einseitig oder beidseitig, Nuten und Applikationen außen oder beidseitig, sowie außenliegenden Ziergittern und LED-Leuchten.

## Technische Beschreibungen und Zubehör

### CLASSIC AC

60 - 67

Diese Modelle sind mit außenliegenden Glasrahmen und geschlossenen Ausführungen mit ebenfalls außenliegenden Zierrahmen ausgestattet. Diese Haustürenerie ist in den Systemen ADS 95.SI, ADS 95AK.SI, ADS 75.SI und ADS 75B.SI erhältlich. Darüber hinaus wählen Sie zwischen flügelüberdeckend einseitig oder beidseitig. Applikationen und Ornamentrahmen können ebenfalls außen oder beidseitig angebracht werden.



### TECHNISCHE BESCHREIBUNGEN

|                                    |         |
|------------------------------------|---------|
| Qualitätsinfo                      | 68      |
| Öffnung, Typenübersicht            | 69      |
| Bedienungskomfort/ LED-Leuchten    | 70      |
| Beispiele Reizvolle Gestaltung     | 71      |
| Schnittzeichnungen / Querschnitte  | 72 - 73 |
| Sicherheit, Einbruchschutz         | 74      |
| Sicherheitstürverschlüsse          | 75 - 77 |
| Zubehör                            | 78 - 82 |
| Verglasungen                       | 83      |
| Farbgestaltungen                   | 84 - 85 |
| Abgebildete Türen in der Übersicht | 86 - 91 |



# TREND

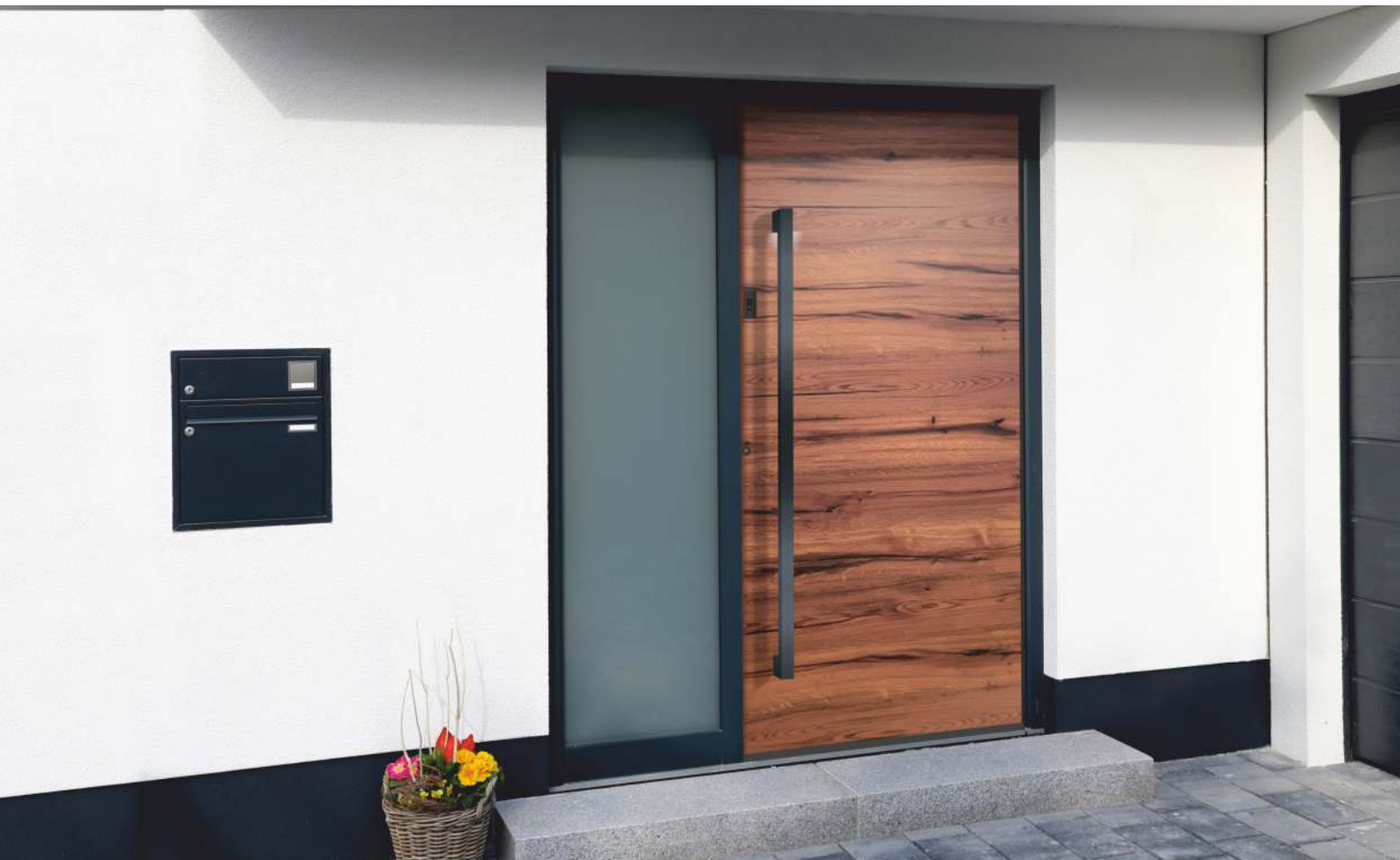

Diese Serie beinhaltet Modelle ohne Verglasungsrahmen und Ausführungen ohne Verglasung. Sie sind in ADS 75B.SI innen und außen flächenbündig und in den Systemen ADS 95.SI, ADS 95AK.SI, ADS 75.SI einseitig flügelüberdeckend oder beidseitig flügelüberdeckend erhältlich. Darüber hinaus wählen Sie zwischen Nuten und Applikationen außen oder beidseitig, sowie außenliegenden Ziergittern und LED-Leuchten. Auf der Seite 84-85 stellen wir Ihnen eine Auswahl gestalterischer Farben vor.



Modell AT 100

|                |                       |
|----------------|-----------------------|
| Farbe          | Cast Iron Fs Metallic |
| Aussengriff    | V 107                 |
| Öffnung        | mit Fingerprint       |
| Wetterschenkel | WSE 03                |



Modell AT 100

|             |   |
|-------------|---|
| Farbe       | Dekor Altholz, querfurniert<br>+ Carbon Night Matt Metallic |
| Aussengriff | P2/7-schwarz  |
| Öffnung     | mit Fingerprint   |



Dekor Altholz



Modell AT 100/AST 100A

Farbe Russet Copper FS Metallic  
 + Cast Iron Fs Metallic  
 Glas Orn. Satinato weiss  
 Aussengriff P2/7 - schwarz  
 Öffnung mit Fingerprint



Modell AT 123

Farbe Cast Iron Fs Metallic  
 + Dekor Altholz, querfurniert  
 Nuten 9/10  
 Aussengriff P 3217- schwarz





Modell AT 100

Farbe Dekor Stadelholz grau,  
querfurniert + Ral 7021  
Aussengriff ZAE 66- schwarz  
Öffnung mit Keypad



Dekor Stadelholz grau



Modell AT 100/ AST 100A

Farbe Dekor Zement hell  
+ Cast Iron Fs Metallic  
Glas Orn. Satinato weiss  
Aussengriff 316 871 - schwarz  
Öffnung mit Fingerprint



Dekor Zement hell



Modell AT 265/ AST 265

Farbe Carbon Night Matt Metallic  
Original Platinum Matt Metallic  
Nuten 4/10  
Glasmotiv SM 265  
Aussengriff SP5G-17 mit Mini-Kamera



Modell AT 265A

Farbe Cast Iron Fs Metallic  
Applikation Edelstahl 4/10  
Aussengriff ZAE 66



Modell AT 264

Farbe Dark Copper Matt Metallic  
 Applikation Edelstahl 2/10  
 Aussengriff GS 113



Modell AT 264A/ AST 264A

Farbe Artic Ice Fs Metallic  
 Nuten 2/10  
 Glasmotiv SM 264A  
 Aussengriff SG-134-1600



Modell AT 266

Farbe Night Grey Fs Metallic  
Nuten 5/20  
Aussengriff SSG-300-1200 Niro



Modell AT 266A

Farbe Dekor Altholz, querfurniert  
+ Night Grey Fs Metallic  
Nuten 5/20  
Aussengriff 316 872 - schwarz



Modell AT 121

Farbe Ral 7035 Fs  
 Nuten 7/10  
 Aussengriff 316 872 schwarzstahl-Optik  
 Hausnummer flächenbündig, schwarz



Modell AT 110

Farbe Original Platinum Matt Metallic  
 Nuten 9/10  
 Aussengriff SG- 180





Modell AT 907B

|             |   |
|-------------|---|
| Farbe       | Original Platinum Matt Metallic<br>+ HD Douglas 7 |
| Applikation | Edelstahl 1/10                                    |
| Aussengriff | ZAE 66  |
| Hausnummer  | flächenbündig,                                    |



Modell AT 907A

|             |                                     |
|-------------|-------------------------------------|
| Farbe       | Dekor Beton dunkel<br>+ Ral 7021 Fs |
| Applikation | Edelstahl 1/10                      |
| Aussengriff | SG-180                              |
| Led-Dioden  | LI                                  |

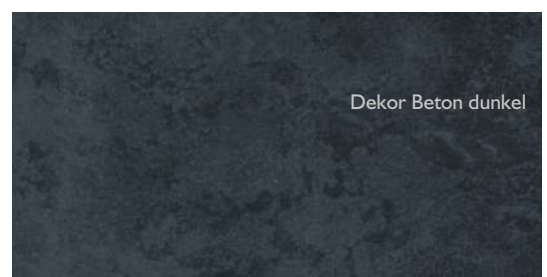

Dekor Beton dunkel



Modell AT 845/ AST 845

Farbe           Granit Nature Fs Metallic  
                   + HD Eiche 2, querfurniert  
 Nuten           3/10  
 Glasmotiv      SM 845  
 Aussengriff   P 3212



Modell AT 919

Farbe           Granit Nature Fs Metallic  
                   + HD Eiche Dunkel  
 Applikation   Edelstahl 4/10  
 Glas           Or. satinato weiss  
 Aussengriff   P 3214





Modell AT 907

Farbe      Granit Nature Fs Metallic  
             + Artic Ice Fs Metallic  
 Applikation   Edelstahl 6/10  
 Aussengriff   P 3212



Modell AT 911/AST 911

Farbe      Granit Nature Fs Metallic  
             + HD Wenge  
 Applikation   Edelstahl 4/10  
 Glasmotiv   SM 911  
 Aussengriff   P 3206



Modell AT 867/ AST 867

Farbe Ral 7016 Fs  
Glasmotiv AG 867A, SM 867A  
Aussengriff 316 872 - schwarz



Modell AT 867

Farbe Ral 9016 Fs  
Glasmotiv AG 867B  
Aussengriff P 1182 schwarz  
mit integriertem Fingerprint



Modell AT 102

Farbe Russet Copper Fs Metallic  
 Glasmotiv SG 102  
 Aussengriff 316 866 schräge Befestigung



Modell AT 101

Farbe Ral 7016 Fs  
 Glas klar  
 Aussengriff P 3217  
 Öffnung mit Fingerprint



Modell AT 100A/ AST 100A

Farbe Ral 9016 Fs  
 Glas Orn. Satinato weiss  
 Aussengriff ZAE 66 - schwarz



Modell AT 941A

Farbe Night Grey Fs Metallic  
 Applikation Edelstahl 7/10  
 Glasmotiv Orn. Satinato weiss  
 Aussengriff SG-124 Arte  
 mit integriertem Fingerprint



Modell AT 906

Farbe Granit Nature Fs Metallic  
 + HD Douglas 7  
 Applikation Edelstahl 6/10  
 Glas SG 906  
 Aussengriff 314 597



Modell AT 906A

Farbe Granit Nature Fs Metallic  
 Applikation Edelstahl 1/20, 5/10  
 Glas Orn. Satinato weiss  
 Aussengriff P 3214



Modell AT 862A/ AST 862A

Farbe 6768 Braun Fs  
 Applikation Edelstahl 6/10  
 Glasmotiv SG 862A, SM 862A  
 Aussengriff P 3214





Modell AT 894

|             |  |
|-------------|--|
| Farbe       | Silver Dream Matt Metallic<br>+ HD Eiche rot |
| Nuten       | 4/10   |
| Glasmotiv   | SG 894                                       |
| Aussengriff | P 3208                                       |
| Led-Dioden  | LI   |



Modell AT 920

|             |   |
|-------------|---|
| Farbe       | Original Platinum Matt Metallic<br>+ HD Eiche rot |
| Applikation | Edelstahl 3/10                                    |
| Glas        | Orn. Satinato weiss                               |
| Aussengriff | P 3214  |



Modell AT 909/ AST 909

|             |                                       |
|-------------|---------------------------------------|
| Farbe       | Night Grey Fs Metallic<br>+ HD Nuss I |
| Applikation | Edelstahl 4/10                        |
| Nuten       | 3/10                                  |
| Glasmotiv   | SM 909                                |
| Aussengriff | 314 597                               |



Modell AT 945A

|             |                             |
|-------------|-----------------------------|
| Farbe       | GSPED 0 Matt<br>+ HD Nuss I |
| Glas        | Orn. Satinato weiss         |
| Aussengriff | P 3217- schwarz             |
| Öffnung     | mit Fingerprint             |





Modell AT 944

|                |                     |
|----------------|---------------------|
| Farbe          | HD Douglas 6        |
| Glas           | Orn. Satinato weiss |
| Aussengriff    | P 3214              |
| Wetterschenkel | WSE 03              |



Modell AT 810/AST 100A

|                |                                 |
|----------------|---------------------------------|
| Farbe          | Original Platinum Matt Metallic |
| Nuten          | 12/10                           |
| Glas           | Orn. Satinato weiss             |
| Aussengriff    | SG -180                         |
| Wetterschenkel | WSE 03                          |



Modell AT 806/ AST 806

Farbe Precious Sand Fs Metallic  
 + HD Eiche dunkel  
 Nuten 12/10  
 Glasmotiv SG 806, SM 806  
 Aussengriff TG 60 gerade Befestigung  
 Led-Dioden LI



Modell AT 946A

Farbe Night Grey Fs Metallic  
 Glasmotiv SG 946A  
 Aussengriff J-137 - Gold Supreme Fs Metallic  
 im Türflügel integriert



Modell AT 946B

Farbe Precious Sand Fs Metallic  
 Nuten 14/20  
 Glasmotiv SG 946A  
 Aussengriff P2/7 - schwarz



Modell AT 924A/ AST 924A

Farbe Rumbling Sky Fs Metallic  
 Nuten 8/10  
 Glas SG 924A, SM 924A  
 Aussengriff SSG-300 120 Niro



Modell AT 843/AST 100A

Farbe Ral 7016 Fs  
Applikation Edelstahl 2/50  
Glas Orn. Satinato weiss  
Aussengriff 314 598



Modell AT 872

Farbe Night Grey Fs Metallic  
Applikation Edelstahl 10/10, 1/20  
Glas Orn. Satinato weiss  
Aussengriff SG-124 Arte  
mit integriertem Fingerprint



Modell AT 901

Farbe Silver Dream Matt Metallic  
 + HD Eiche rot, querfurniert  
 Applikation Edelstahl 2/30  
 Glas Orn. Satinato weiss  
 Aussengriff P 3214



Modell AT 866B/ AST 866B

Farbe Original Platinum Matt Metallic  
 Applikation Edelstahl 2 Formen  
 Glasmotiv SG 866B, SM 866B  
 Aussengriff P 3217





Modell AT 934A

|             |                           |
|-------------|---------------------------|
| Farbe       | Granit Nature Fs Metallic |
| Glas        | Orn. Satinato weiss       |
| Aussengriff | P 3217 - schwarz          |



Modell AT 934

|                |                       |
|----------------|-----------------------|
| Farbe          | Cast Iron Fs Metallic |
| Applikation    | Edelstahl 4/10        |
| Glas           | Orn. Satinato weiss   |
| Aussengriff    | P 3212                |
| Wetterschenkel | WSE 03                |



Modell AT 863A/ AST 863A

|             |                        |
|-------------|------------------------|
| Farbe       | Rostiges Eisen Fs      |
| Applikation | Edelstahl 4/10         |
| Glasmotiv   | Sandgestrahlt, SM 863A |
| Aussengriff | P 3214                 |



Modell AT 863B

|                |   |
|----------------|---|
| Farbe          | DB 703 Metallic glatt                       |
| Nuten          | 5/10  |
| Glas           | Orn. Satinato weiss                         |
| Aussengriff    | SG 124 Arte<br>mit integriertem Fingerprint |
| Wetterschenkel | WSE 03                                      |





Modell AT 863C

Farbe Brown Fs Metallic  
 Applikation Edelstahl 7/10  
 Glas Orn. Satinato weiss  
 Aussengriff P 3217



Modell AT 947/AST 947

Farbe Cast Iron Fs Metallic  
 Glasmotiv Sandgestrahlt, SM 947  
 Aussengriff SSG-300 1200 Niro



Modell AT 875A

Farbe Noble Bronze Matt Metallic  
Applikation Edelstahl 2/10  
Glas Orn. Satinato weiss  
Aussengriff 314 597



Modell AT 131

Farbe HD Eiche 4, querfurniert  
Ral 7021 Fs  
Glas Orn. Satinato weiss  
Aussengriff P 1182 - schwarz  
mit integriertem Fingerprint



Modell AT 875B

Farbe HD Kirsch 3  
 Nuten 2/10  
 Glas Orn. Satinato weiss  
 Aussengriff ZAE 66 - schwarz



Modell AT 948/ AST 948

Farbe Artic Ice Fs Metallic  
 Nuten 2/10  
 Glasmotiv Sandgestrahl, SM 948  
 Aussengriff ZAE 66 - schwarz



Modell AT 893

Farbe           Granit Nature Fs Metallic  
                   + HD Eiche dunkel  
 Applikation   Edelstahl 2/30  
 Glasmotiv     Orn. Satinato weiss  
 Aussengriff   316 847



Modell AT 258A

Farbe           Granit Nature Fs Metallic  
 Glas            Orn. Satinato weiss  
 Aussengriff   SG 124 arte  
                   mit integriertem Fingerprint



Modell AT 891

|             |  |
|-------------|--|
| Farbe       | GSPED 0 Matt<br>+ HD Wenge, querfurniert |
| Applikation | Edelstahl 2/30                           |
| Glasmotiv   | SG 891                                   |
| Aussengriff | P 3217                                   |



Modell AT 891A

|             |            |
|-------------|------------|
| Farbe       | HD Eiche 2 |
| Nuten       | 6/20       |
| Glasmotiv   | SG 891A    |
| Aussengriff | P 3214     |



Modell AT 864/ AST 864

|             |                       |
|-------------|-----------------------|
| Farbe       | GSPED 3 Matt          |
| Nuten       | 6/10                  |
| Glasmotiv   | Sandgestrahlt, SM 864 |
| Aussengriff | 316 860               |





Modell AT 904

Farbe Volcanish Ash Fs Metallic  
 Applikation Edelstahl 4/20, 1/60  
 Glas Orn. Satinato weiss  
 Aussengriff 316 860



Modell AT 943

Farbe Original Platinum Matt Metallic  
 Applikation Edelstahl 9/10  
 Glas Orn. Satinato weiss  
 Aussengriff SSG-300 1200 Niro

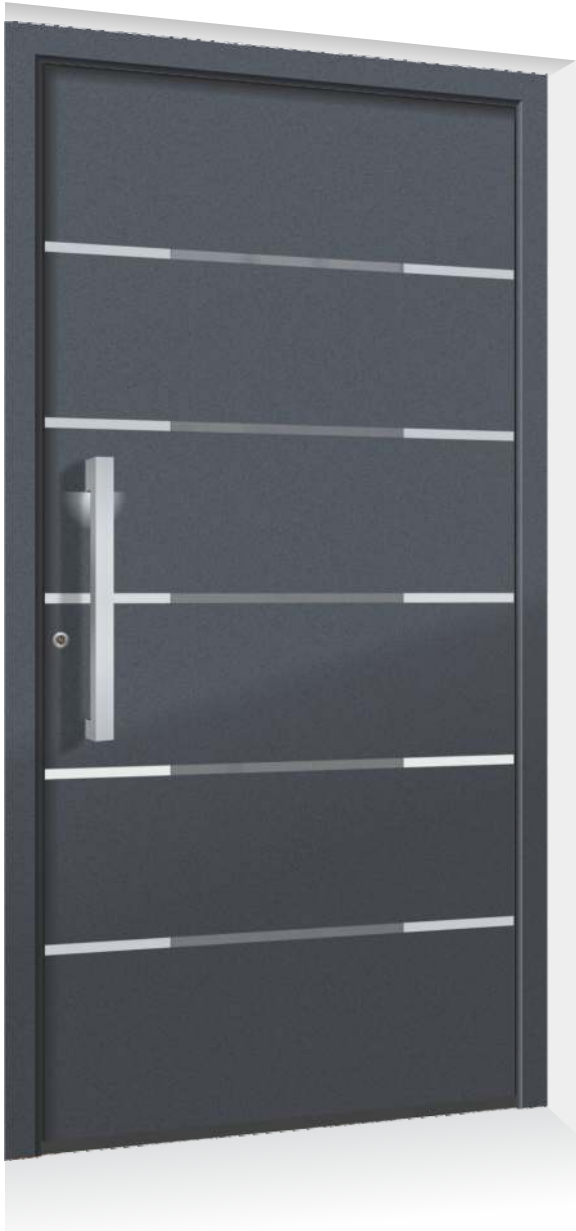

Modell AT 267

Farbe DB 703 Metallic glatt  
Applikation Edelstahl 10/20  
Glas nur in Orn. Satinato weiss beidseitig  
Aussengriff P 2/2



Modell AT 137

Farbe GSPED 3 Matt  
Glas Orn. Satinato weiss  
Aussengriff SSG-300 1200 Niro





Modell AT 889A

Farbe Dark Copper Matt Metallic  
 Applikation Russet Copper Fs Metallic  
 Edelstahl 2 Formen  
 Nuten 6/10  
 Glas Orn. Satinato weiss  
 Aussengriff P 1182 mit integriertem Fingerprint



Modell AT 255/ AST 255

Farbe Precious Sand Fs Metallic  
 + HD Eiche Dunkel, querfurniert  
 Nuten 5/10  
 Glasmotiv Sandgestrahlt, SM 255  
 Aussengriff F5/6



Modell AT 885A/ AST 885A

Farbe Carbon Night Matt Metallic  
 + HD Walnuss dunkel  
 Nuten 5/10  
 Glasmotiv Sandgestrahlt, SM 885  
 Aussengriff ZAE 66



Modell AT 885

Farbe Ral 9016 Fs  
 Granit Nature Fs Metallic  
 Applikation Edelstahl 1/60, 3/10  
 Nuten 2/10  
 Glas Orn. Satinato weiss  
 Aussengriff P 1182  
 mit integriertem Fingerprint



Modell AT 153A

Farbe Cast Iron Fs Metallic  
 Glas Orn. Satinato weiss  
 Aussengriff ZAE 66R  
 Öffnung mit Fingerprint



Modell AT 881A

Farbe Granit Nature Fs Metallic  
 + Artic Ice Fs Metallic  
 Applikation Edelstahl 1/80  
 Glas Orn. Satinato weiss  
 Aussengriff ZAE 66  
 Öffnung mit Fingerprint



Modell AT 883/AST 883

Farbe Rumbling Sky Fs Metallic  
 + Artic Ice Fs Metallic  
 Applikation Edelstahl 3/10 + 1 Form  
 Glasmotiv Sandgestrahlt, SM 883  
 Aussengriff P 1182 mit integriertem  
 Fingerprint



Modell AT 887

Farbe Original Platinum Matt Metallic  
+ HD Eiche dunkel  
Applikation Edelstahl 4/10  
Glas Orn. Satinato weiss  
Aussengriff ZAE 66R  
Öffnung mit Fingerprint



Modell AT 887D

Farbe GSPED 0 Matt  
+ HD Douglas 6  
Applikation Edelstahl 1/60, 1/10  
Glas Orn. Satinato weiss  
Aussengriff ZAE 66  
Öffnung mit Fingerprint



Modell AT 887B

|             |   |
|-------------|---|
| Farbe       | GSPED 0 Matt                                |
| Nuten       | 4/10  |
| Glasmotiv   | SG 887B                                     |
| Aussengriff | SG 124 Arte<br>mit integriertem Fingerprint |



Modell AT 887E/ AST 887E

|             |   |
|-------------|---|
| Farbe       | Granit Nature Fs Metallic<br>+ HD Wenge |
| Nuten       | 5/10                                    |
| Glasmotiv   | Sandgestrahlt, SM 887E                  |
| Aussengriff | ZAE 66R                                 |
| Öffnung     | mit Fingerprint                         |

# DELUXE



Diese Modelle zeichnen sich durch Gläser mit Edelstahl- und Aluminiumrahmen bzw. durch außen oder beidseitig angebrachten Applikationen aus. Sie sind in ADS 75B.SI innen und außen flächenbündig und in den Systemen ADS 95.SI, ADS 95AK.SI, ADS 75.SI einseitig flügelüberdeckend oder beidseitig flügelüberdeckend erhältlich. Darüber hinaus wählen Sie zwischen Nuten außen oder beidseitig und LED-Leuchten. Auf der Seite 84-85 stellen wir Ihnen eine Auswahl gestalterischer Farben vor.



Modell AD 863D

|             |                        |
|-------------|------------------------|
| Farbe       | Night Grey Fs Metallic |
| Applikation | Edelstahl              |
| Glasmotiv   | Orn. satinato weiss    |
| Aussengriff | ZAE 66                 |



Modell AD 843A

|             |                     |
|-------------|---------------------|
| Farbe       | DB 703 Metallic Fs  |
| Applikation | Edelstahl           |
| Glas        | Orn. Satinato weiss |
| Aussengriff | 314 598             |



Modell AD 945A/ AST 945

|             |                       |
|-------------|-----------------------|
| Farbe       | DB 703 Metallic glatt |
| Applikation | Edelstahl             |
| Nuten       | 1/10                  |
| Glasmotiv   | SG 945, SM 945        |
| Aussengriff | SG 124 Arte           |



Modell AD 945

|             |                         |
|-------------|-------------------------|
| Farbe       | Ral 9007 Metallic glatt |
| Applikation | Edelstahl               |
| Glasmotiv   | Orn. Satinato weiss     |
| Aussengriff | P 3217                  |





Modell AD 852A

Farbe GSPED 0  
 Applikation Alu HD Wenge  
 Glas Orn. Satinato weiss  
 Aussengriff SG-49



Modell AD 801A/AST 801

Farbe Granit Nature Fs Metallic  
 Applikation Alu HD Kirsch 2  
 Edelstahl  
 Glas Orn. Satinato weiss  
 Aussengriff P 3214



Modell AD 802A

Farbe Ral 9016 PFs  
 Applikation Alu Ral 7021 Fs  
 Glas Orn. Satinato weiss  
 Aussengriff 316 872 - schwarz  
 Öffnung mit Fingerprint



Modell AD 875C

Farbe Granit Nature Fs Metallic  
 Applikation Edelstahl  
 Glasmotiv Orn. Satinato weiss  
 Aussengriff 316 866 schräge Befestigung



Modell AD 923

|             |                           |
|-------------|---------------------------|
| Farbe       | Precious Sand Fs Metallic |
| Applikation | Alu HD Wenge<br>Edelstahl |
| Glas        | Orn. Satinato weiss       |
| Aussengriff | TG 60 schräge Befestigung |



Modell AD 168/AST 168

|             |  |
|-------------|--|
| Farbe       | Ral 9016 Fs                                |
| Applikation | Alu Precious Sand Fs Metallic<br>Edelstahl |
| Nuten       | 4/10                                       |
| Glasmotiv   | Sandgestrahlt, SM 168                      |
| Aussengriff | ZAE 66                                     |

# MODERN



Bei den Ausführungen dieser Serie sind die Gläser von außen mit einem Aluminium-Verglasungsrahmen eingelassen. Modelle erhalten Sie in den Systemen ADS 95.SI, ADS 95AK.SI, ADS 75.SI und ADS 75B.SI. Darüber hinaus wählen Sie zwischen flügelüberdeckend einseitig oder beidseitig, Nuten und Applikationen außen oder beidseitig, sowie außenliegenden Ziergittern und LED-Leuchten. Auf der Seite 84-85 stellen wir Ihnen eine Auswahl gestalterischer Farben vor.



Modell AM 863D

Farbe HD Eiche 2  
 Glas Orn. Satinato weiss  
 Aussengriff P2/7 - schwarz



Modell AM 863D

Farbe Granit Nature Fs Metallic  
 Glas Orn. Satinato weiss  
 Aussengriff ZAE 66



Modell AM 945A

Farbe Original Platinum Matt Metallic  
Zierritter + HD Nuss I  
Glas Orn. Satinato weiss  
Aussengriff P 3217



Modell AM 132A

Farbe Ral 9016 Fs  
Glas Orn. Satinato weiss  
Aussengriff TG 80 schräge Befestigung



Modell AM 134B

Farbe Ral 9016 Fs  
 Glas Orn. Satinato weiss  
 Aussengriff SG-134-1600



Modell AM 172C

Farbe Granit Nature Fs Metallic  
 + HD Golden Oak  
 Glas Orn. Satinato weiss  
 Aussengriff P 3217



Modell AM 875C

Farbe Noble Bronze Matt Metallic  
Glas Orn. Satinato weiss  
Aussengriff ZAE 66



Modell AM 131

Farbe Ral 9016  
Glas Orn. Satinato weiss  
Aussengriff 316 866 schräge Befestigung  
Wetterschenkel WSE 01





Modell AM 156

|             |                                 |
|-------------|---------------------------------|
| Farbe       | Original Platinum Matt Metallic |
| Nuten       | 3/10                            |
| Glas        | Orn. Satinato weiss             |
| Aussengriff | SG-180                          |
| Öffnung     | mit Fingerprint                 |



Modell AM 133A

|                |                           |
|----------------|---------------------------|
| Farbe          | Granit Nature Fs Metallic |
| Glas           | Orn. Satinato weiss       |
| Aussengriff    | SSG-300-1200 Niro         |
| Wetterschenkel | WSE 02                    |



Modell AM 181

|             |                                |
|-------------|--------------------------------|
| Farbe       | GSPED 0 Matt<br>+ HD Douglas 7 |
| Applikation | Edelstahl                      |
| Nuten       | 5/10                           |
| Glas        | Orn. Satinato weiss            |
| Aussengriff | 314 598                        |



Modell AM 170

|                |                             |
|----------------|-----------------------------|
| Farbe          | HD Douglas 2                |
| Glas           | Orn. Satinato weiss         |
| Aussengriff    | 316 861 schräge Befestigung |
| Wetterschenkel | WSE 02                      |



Modell AM 222

|             |                          |
|-------------|--------------------------|
| Farbe       | DB 703 Metallic glatt    |
| Zierritter  | 3 x Typ I                |
| Glas        | Orn. Satinato weiss      |
| Aussengriff | TG 80 gerade Befestigung |



Modell AM 180

|             |                     |
|-------------|---------------------|
| Farbe       | GSPED 2 Matt        |
| Nuten       | 10/10               |
| Glas        | Orn. Satinato weiss |
| Aussengriff | 316 866             |

# CLASSIC



Diese Modelle sind mit außenliegenden Glasrahmen und geschlossenen Ausführungen mit ebenfalls außenliegenden Zierrahmen ausgestattet. Diese Haustürenserie ist in den Systemen ADS 95.SI, ADS 95AK.SI, ADS 75.SI und ADS 75B.SI erhältlich. Darüber hinaus wählen Sie zwischen flügelüberdeckend einseitig oder beidseitig. Applikationen und Ornamentrahmen können ebenfalls außen oder beidseitig angebracht werden. Auf der Seite 84-85 stellen wir Ihnen eine Auswahl gestalterischer Farben vor.



Modell AC 182

Farbe HD Kirsch 3  
 Aussengriff 316 866 schräge Befestigung



Modell AC 207

Farbe Granit Nature Fs Metallic  
 Glasmotiv Sandgestrahlt mit Facettenschliff  
 Aussengriff TG 80 schräge Befestigung



Modell AC 182A

Farbe Ral 7016 Fs  
Glasmotiv BV 64  
Aussengriff 316 866 schräge Befestigung



Modell AC 184

Farbe Ral 9016 Fs  
Glasmotiv Ornamentglas  
Aussengriff 316 866 schräge Befestigung



Modell AC 186

Farbe HD Eiche 4  
 Glasmotiv AS 039  
 Aussengriff 316 866  
 schräge Befestigung



Modell AC 185/AST 185

Farbe Original Platinium Matt metallic  
 Glasmotiv AS 038, AS 038A  
 Aussengriff 316 866  
 schräge Befestigung



Modell AC 191/AST 191

Farbe Verdigris Fs Metallic  
Glasmotiv 3 x AB 07  
Aussengriff 316 866 schräge Befestigung



Modell AC 192

Farbe Ral 9016 Fs  
Glas Ornamentglas  
Aussengriff 316 866 schräge Befestigung





Modell AC 203A

Farbe HD Eiche 2  
 Glasmotiv BV 67  
 Aussengriff 316 866  
 schräge Befestigung



Modell AC 183

Farbe Ral 6005 Fs, Ral 9016 Fs  
 Glas Ornamentglas  
 Aussengriff 316 866 schräge  
 Befestigung



Modell AC 190A/ AST 190

Farbe Precious Sand Fs Metallic  
 Glasmotiv 3 x AB 06  
 Aussengriff 316 866  
 schräge Befestigung



Modell AC 206

Farbe HD Kirsch 3  
Glasmotiv AS 044  
Aussengriff TG 60 schräge Befestigung



Modell AC 194A

Farbe Precious Sand Fs Metallic  
Glas BV 56 + AB 012  
Aussengriff TG 60 schräge Befestigung



Modell AC 209A

|             |                             |
|-------------|-----------------------------|
| Farbe       | Ral 5014 Fs                 |
| Glasmotiv   | BV 69                       |
| Aussengriff | 316 866 schräge Befestigung |



Modell AC 195A

|             |                             |
|-------------|-----------------------------|
| Farbe       | Ral 9016 Fs                 |
| Glasmotiv   | BV 57                       |
| Aussengriff | 316 866 schräge Befestigung |

## ALUPROFILE

- Das Alurahmenprofil in der Stärke 75 oder 95mm mit gerader, und eckiger abgerundeter Linienführungen. ADS 75B.SI - beidseitig flächenbündige Ausführung.
- Das Alufügelprofil hat die Stärke 85 mm und 75 mm.
- In der Mitte des Rahmen- und Flügelprofils ist ein Thermokern, der die Wärmedämmcharakteristik des Profils verbessert.
- Die Füllungen sind aus hartem PUR Schaum und haben eine gute Wärmedämmcharakteristik.
- Bei den Ausführungen beidseitig flügelüberdeckend ohne Glasausschnitt wird ein Ud Wert von 0,81 W/m<sup>2</sup>K erreicht. Ein Ud Wert von 1,2 W/m<sup>2</sup>K wird bei einseitig flügelüberdeckenden Alu-Haustüren erzielt.



## BESCHLAG

- Elegante Qualitätsbänder.
- Standard 5-fach Verriegelung des Flügels.
- Verschiedene Öffnungsoptionen; öffnen nach außen, öffnen mit einem Fingerprintsystem, elektrisches öffnen, .....

## VERGLASUNG

- Zur Auswahl steht Ihnen eine breite Palette an Wärme-, Schallschutz und Sicherheitsgläsern, sowie an Ornament- und Bleiverglasungen.
- Zur Gestaltung der Gläser stehen Ihnen verschiedene Folien, sandgestrahlte Motive und andere Gestaltungsmöglichkeiten zur Verfügung.



## OBERFLÄCHENBECHANDLUNG

- Eine qualitäts und umweltfreundliche Pulverbeschichtung.
- Eine große Auswahl aktueller Standardfarben.
- Zur Verfügung stehen RAL Farben matt, RAL Feinstruktur, Metallic- und einbrennlackierte Holzdekore.

ÖFFNUNG

Nach innen öffnende Türen, Ansicht von **außen**



DIN LINKS



DIN RECHTS

TYPENÜBERSICHT

Nach innen öffnende Türen, Ansicht von **innen**

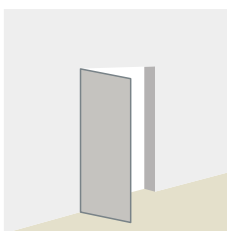

Typ 01

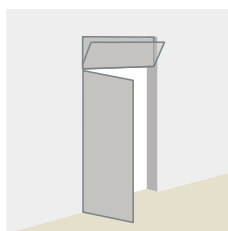

Typ 02/03

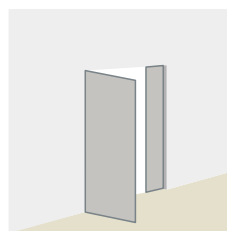

Typ 04

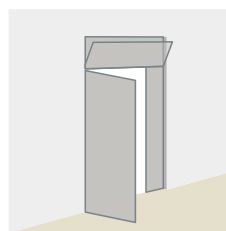

Typ 05/06

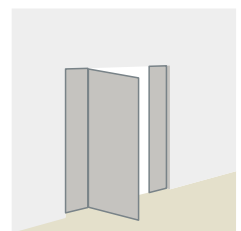

Typ 07

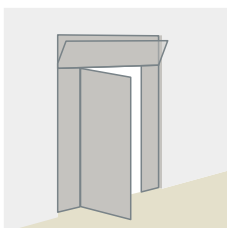

Typ 08/09

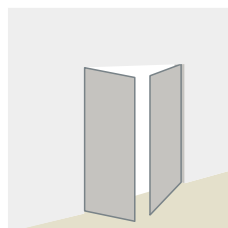

Typ 21

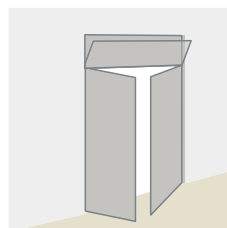

Typ 22/23

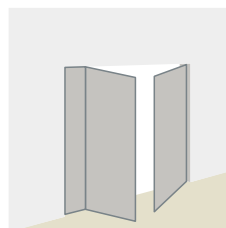

Typ 24

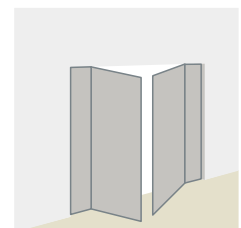

Typ 25

## Aluminium Haustür **aussen**

Modell AT 100, System ADS 75B.SI

**außen flächenbündig**

Farbe: Flügel HD EICHE 4, querfurniert

Rahmen: RAL 7016 Fs



## Holz/Alu Fenster **außen**

INO-HA80-MM **flächenbündig**

INO-HA80-F **flächenbündig**

Farbe Alu: RAL 7016 Fs

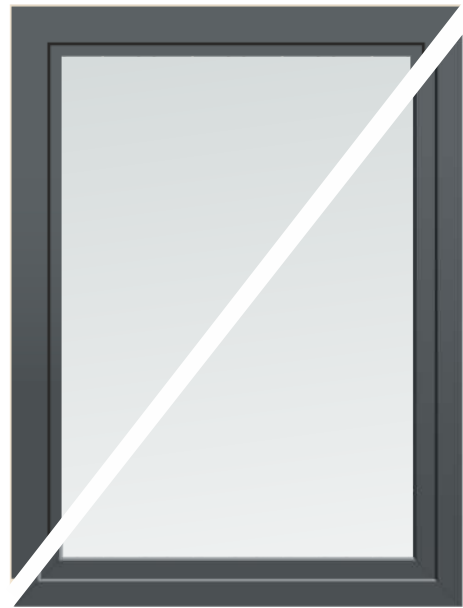

## Kunststoff/Alu Fenster **außen**

Living Top Alu **flächenversetzt**

Farbe Alu: RAL 7016 Fs

### BEDIENUNGSKOMFORT



Öffnung der Haustüre  
mit dLine Fingerprint



Öffnung der Haustüre  
mit Fingerprint



Griff mit integriertem  
Fingerprint ARTE



Öffnung der Haustüre  
mit Keypad

**Aluminium Haustür innen**

Modell AT 100, System ADS 75B.SI  
 innen flächenbündig  
 Farbe: Flügel und Rahmen: RAL 7016 Fs



**Holz/Alu Fenster innen**

INO-HA80-MM flächenbündig  
 INO-HA80-F flächenversetzt  
 Farbe Holz: RAL 7016



**Kunststoff/Alu Fenster innen**

Living Top Alu flächenversetzt  
 Farbe Kunststoff: RAL 7016

LED LEUCHTEN



Außengriff mit integriertem Led-Leucht,  
 Kratzerschutz und Edelstahl Applikation



LED-Diode

DIGITALER TÜRSPION



mit LCD - Bildschirm

SYSTEM AUSFÜHRUNGEN



**ADS 95AK.SI**  
Eckig Rahmen

Beidseitig flügelüberdeckende Ausführung

**$U_d = 0,81 \text{ W/m}^2\text{K}$**   
(ohne Glasausschnitt)



**ADS 95.SI**  
Rund Rahmen

Dreifach  
Verglasung

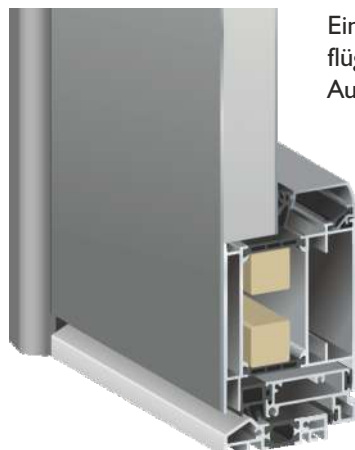
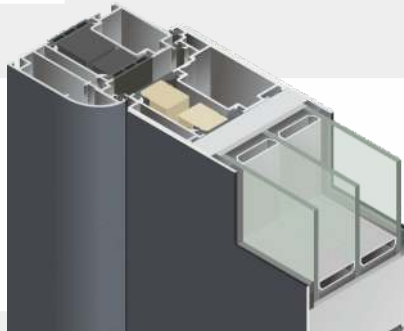

Einseitig  
flügelüberdeckende  
Ausführung aussen

**$U_d = 1,2 \text{ W/m}^2\text{K}$**   
(ohne Glasausschnitt)



Ausführungen mit  
sichtbarem Flügel

Bei diesen Modellen sind die Flügel sichtbar und dieses sowohl innen als auch außen. Sie sind in allen Haustürenausführungen außer in der Deluxe Serie erhältlich.





**ADS 75B.SI**

Innen und außen  
flächenbündig

Beidseitig flügelüberdeckende Ausführung

**Ud = 0,81 W/m²K**

(ohne Glasausschnitt)



**ADS 75.SI**

außen flächenbündig

VERGLASUNGSRAHMEN AUSFÜHRUNGEN

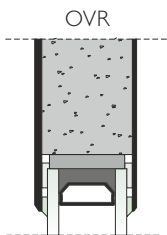

Serie TREND

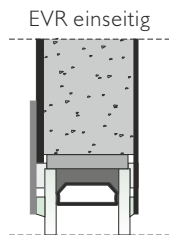

Serie DELUXE  
(Standardausführung)

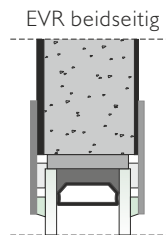

Serie DELUXE

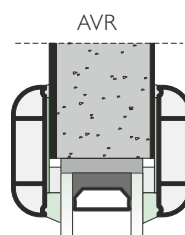

Serien MODERN, CLASSIC

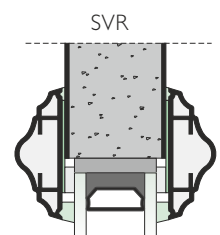

RC2 wir beraten Sie dazu gerne ausführlich.

Die Sicherheit einer Immobilie war und ist ein aktuelles Thema bei dem Kauf von Alu-Haustüren. Ergänzend zu dem in diesem Sinne hohen Qualitätsstandard der Alu-Haustüren als solches, sind diese mit **5-fach Verriegelung (Bolzen und Schwenkriegel)** als **Standardverriegelung** ausgerüstet. Des Weiteren erhalten Sie ISARHOLZ-Alu-Haustüren in den **zertifizierten Sicherheitsstufen RCI und RC2**. Darüber hinaus stehen Ihnen weitere detailrelevante Verriegelungen zur Verfügung. Für einen hohen Bedienungskomfort erhalten Sie individuelle Einrichtungen.

Über die **Sicherheitseinrichtungen für ISARHOLZ-Holz- und Holz/Alu- und Kunststoff-Haustüren** informiert Sie Ihr ISARHOLZ-Fachbetrieb.



## RC2 AUSFÜHRUNG

1 SICHERUNGSBOLZEN



2 SICHERHEITSGLAS P4A



3 FALZLUFTBEGRENZER



4 SICHERHEITSPROFILZYLINDER MIT ANBOHRSCHUTZ

5 SICHERHEITSGARNITUR



3 DREITEILIGES TÜRBÄNDER



Serienmäßig bis Türhöhe 2150 mm mit 3 Bänder und ab 2151 mm mit 4 Bänder gefertigt (standard)

4 TÜRSCHWELLEN

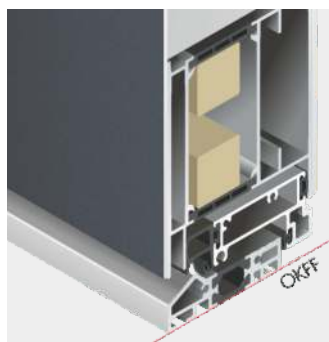

FPI (standard)

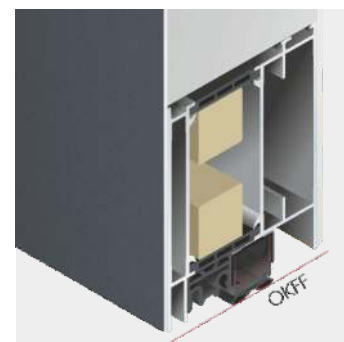

FP5 automatische Türabdichtung

# SICHERHEITSTÜRVERSCHLÜßE



**ATVE 5**  
**5-fach Verriegelung**  
 - Edelstahl  
 mit Bolzen und  
 Schwenkriegel

**Serienmäßige  
 Sicherheit**

- mechanische  
 Mehrfachverriegelung

- 5-fach Schutz durch  
 einen Hauptriegel,  
 2 Bolzen und  
 2 Schwenkriegel



**ATVK 5**  
**5-fach Verriegelung  
 mit Komfortfunktion**  
 - Edelstahl,  
 mit Bolzen und  
 Schwenkriegel

- Mechanisch Öffnen der Tür  
 über Drücker immer möglich  
 (Komfortöffnung)
- Ein Freilaufzylinder oder ein  
 Knaufzylinder erforderlich
- Möglich nur in der Kombination  
 außen Stoßgriff - innen Drücker  
 (Drücker außenseitig nicht  
 möglich)

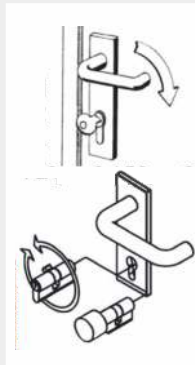

Komfortfunktion  
 = Schnellöffnung  
 von innen über  
 den Drücker

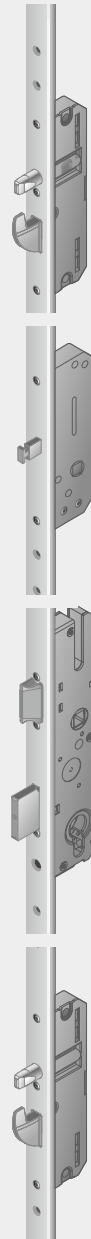

**ATVS 5**  
**5-fach Verriegelung**  
 - Edelstahl  
 mit Bolzen,  
 Schwenkriegel  
 und **Türfänger**

Der spezialgehärtete Sperrbügel  
 sorgt dafür, dass sich die Tür  
 nur einen Spalt breit öffnet, sodass  
 sich kein ungebetener Gast zwischen  
 Tür und Stock durchzwängen kann.

Von innen lässt sich das Fängerschloss  
 einfach über einen Drehknopf  
 bedienen, von außen wird es mit dem  
 Schlüssel über das Hauptschloss  
 betätigt.



## ELEKTRO-TÜRÖFFNER



## VERDECKTLIEGENDE TÜRBÄNDER



Für nach innen öffnende  
 Türen - 100° Öffnungswinkel



Für nach außen öffnende  
 Türen und ADS 75B.SI - 180°



**ATVE A**  
5-fach Sicherheits-  
türverschuß  
AUTOMATIK,  
MECHANISCH

- die selbstverriegelnden Fallenriegel
- die 4 Fallenriegel beim Zuziehen der Türe automatisch 20 mm vorschließen und gegen ein Zurückdrücken gesichert sind.
- durch zusätzliches manuelles Verriegeln wird der Riegel des Hauptschlusses vorgeschlossen und der Türdrücker blockiert.

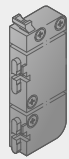

**ATVE A-M**  
5-fach Sicherheits-  
türverschuß  
AUTOMATIK,  
mit motorischer  
Funktion,  
inkl. Netzteil

- Verriegelungselemente lassen sich mechanisch verriegeln
- Entriegelung über die Rücksprechanlage, Biometrie, ... (der Riegel des Hauptschlusses darf nicht vorgeschlossen sein)



**ATVS 5EAF**  
5-fach Verriegelung  
-Edelstah + Ekey,  
inkl. Netzteil mit elektromechanischem  
Antrieb, Fingerscann und Freilauf-Profilzylinder  
mit Aufbohrschutz und Gefahrenfunktion  
einschließlich 6 Schlüsseln

Sobald die Tür geschlossen ist, erfolgt im Nachtbetrieb eine automatische Verriegelung durch den Motor (ca. 3 sec.). Alle vorhandenen Verschlusselemente werden herausgefahren.  
Die Tür kann manuell durch den Zylinderschlüssel oder automatisch über ein externes Zutrittskontrollsystem entriegelt werden.  
Wenn die Tür vollständig verriegelt ist, ist es auch möglich, von innen über den Drücker alle Riegelemente zurückzufahren und die Tür so schnell zu öffnen.



dLine



Ekey in Schwarz Farbe



Ekey

**ATVS 5EAFI**  
5-fach Verriegelung  
-Edelstah + IDENCOM,  
inkl. Netzteil mit  
elektromechanischem  
Antrieb, Fingerscann und  
Freilauf-Profilzylinder  
mit Aufbohrschutz und  
Gefahrenfunktion  
einschließlich 6 Schlüsseln



Idencom

## PROFILZYLINDER



Profilzylinder mit Not- und Gefahrenfunktion und 6 Schlüsseln (standard)



Profilzylinder mit Aufbohrschutz und 6 Schlüsseln



Freilauf-Profilzylinder mit Aufbohrschutz und Gefahrenfunktion einschließlich 6 Schlüsseln



## Aluminium Haustür **aussen**

Modell AT 862A, System ADS95AK.SI

Farbe: Cast Iron Fs Metallic

HAUSNUMMER MOTIVGLAS



TÜRSPION



Messing poliert / Satin Chrom

AUSSEN RUNDROSETTE



Edelstahl  
(standard)

schwarz



WETTERSCHENKEL



Briefkasten-Systeme



WSE 03 als Edelstahl Applikation



WSE 01 aus Edelstahl



WSE 02 aus Edelstahl ohne Löcher

### Aluminium Haustür innen

Modell AT 862A, System ADS95AK.SI  
Farbe: Ral 9016

Türschließer TS 5000



#### INNENGRIFFE, INNENROSETTE

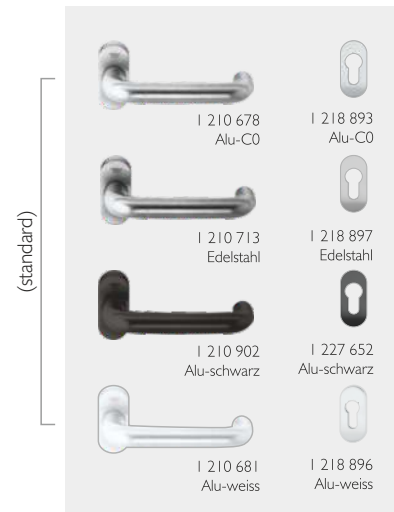
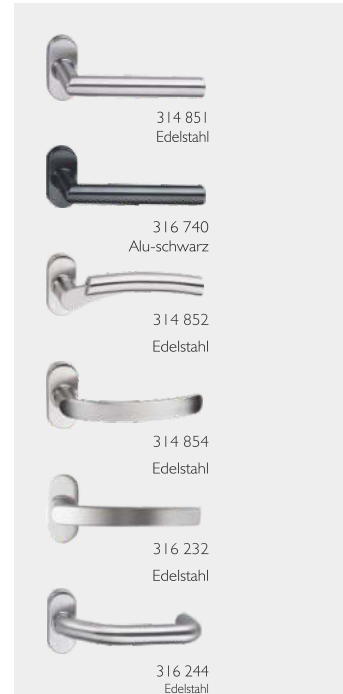

Dreiteilige Rolltürbänder, Innengriffe und Innenrosetten farblich aufeinander abgestimmt

AUßENGRIFFE

|   |  |  |  |   |
|---|--|--|--|---|
| <p>Edelstahl matt</p> <p>P 3202 L=350 mm    P 3214 L=1500 mm</p> <p>P 3204 L=550 mm    P 3216 L=1800 mm</p> <p>P 3206 L=750 mm    P 3218 L=2000 mm</p> <p>P 3208 L=950 mm    P 3217 L=X mm</p> <p>P 3210 L=1150 mm</p> <p>P 3212 L=1350 mm</p> <p>Schwarz</p> <p>P 3217 L = x</p> | <p>Edelstahl matt</p> <p>Mit schräger Befestigung</p> <p>316 865 L=400 mm</p> <p>316 866 L=600 mm</p> <p>316 867 L=800 mm</p> <p>316 868 L=1000 mm</p> <p>316 869 L=1200 mm</p> <p>Mit gerader Befestigung</p> <p>316 860 L=400 mm</p> <p>316 861 L=600 mm</p> <p>316 862 L=800 mm</p> <p>316 863 L=1000 mm</p> <p>316 864 L=1200 mm</p> | <p>Edelstahl matt</p> <p>314 585 L=400 mm</p> <p>314 586 L=800 mm</p> <p>314 597 L=1200 mm</p> <p>314 598 L=1600 mm</p> <p>316 847 L=1800 mm</p> <p>314 599 L=2000 mm</p> <p>Schwarzstahl - Optik</p> <p>316 870 L=1000 mm</p> <p>316 871 L=1200 mm</p> <p>316 872 L=1400 mm</p> <p>316 848 L=1600 mm</p> <p>316 849 L=1800 mm</p> | <p>Edelstahl matt / Holz</p> <p>SG-180 L=1200 mm</p> | <p>Edelstahl matt / Holz</p> <p>SG-124 ARTE L=1200 mm</p> <p>Mit integriertem Fingerprint</p> <p>SPSG-17 L=1200 mm</p> <p>Mit Mini-Kamera</p> |
|---|--|--|--|---|







AUßENROSETTE

|   |   |   |   |   |
|---|---|---|---|---|
| Edelstahl   | Schwarz   | Edelstahl   | Edelstahl   | Schwarz   |
|  |  |  |  |  |
| RRE   | RRE-S   | 316 238   | 316 239 (6)<br>316 240 (9)  | 316 741 (6)<br>316 742 (9)  |

KRATZERSCHUTZ

|   |   |
|---|---|
| Edelstahl   | Edelstahl   |
|  |  |
| 381 112<br>60 X 75 mm   | 381 114<br>55 X 75 mm   |

Mit integriertem Fingerprint

|   |   |   |   |  |   |
|---|---|---|---|--|---|
|  |  |  |  |  |  |
| Edelstahl matt<br>P 1182<br>L=550 mm  | Schwarz<br>P 1182<br>L=550 mm   | Edelstahl matt<br>P 1180<br>L=550 mm  | Schwarz<br>P 1180<br>L=550 mm   | Edelstahl matt<br>P 1179<br>L=550 mm   | Edelstahl<br>E35303<br>L=330 mm<br>E43303<br>L=400 mm<br>E63303<br>L=600 mm           |





Edelstahl matt/  
Beton-Optik

SSG-300  
-I200 Niro  
L=1200 mm

Edelstahl matt

Mit schräger  
oder gerader  
Befestigung

TG 50  
L=500 mm

TG 60  
L=600 mm

TG 80  
L=800 mm

TG 100  
L=1000 mm

TG 120  
L=1200 mm

TG 140  
L=1400 mm

TG 160  
L=1600 mm

TG 180  
L=1800 mm



Edelstahl matt

P2/2  
l=550 mm

P2/4  
l=950 mm

P2/6  
l=1350 mm

P2/7  
l=1500 mm

Mit Beleuchtung

P2/7-schwarz  
l=1500 mm

Mit Beleuchtung



Edelstahl matt

F5/2  
L=550 mm

F5/4  
L=950 mm

F5/6  
L=1350 mm

F5/7  
L=1500 mm

Mit Beleuchtung

F5/7 - schwarz  
L=1500 mm

Mit Beleuchtung



Edelstahl matt /  
Jatoba Holz

SG-134-I600  
L=1600 mm







Edelstahl matt

ZAE 66  
L = x

ZAE 66  
schwarz  
L = x

LED-DIODEN, Licht farbe weiß, Led-Diodelampe Edelstahl

-  L 1 (57 x 57 mm)
-  L 2 (Ø=41 mm)
-  L 4 (Ø=35 mm)
-  L 3 (Ø=60 mm)
-  L 5 (Ø=30 mm)



Robusta Gold  
314 543  
L=250 mm



Brüniert  
314 544  
L=250 mm



Messing poliert  
284 744  
L=330 mm



Edelstahl matt  
284 487  
L=380 mm



Edelstahl matt  
ZAE 66R  
L=X mm



Edelstahl matt  
P 1176  
L=380 mm



Edelstahl matt  
P 1177  
L=380 mm

STOßGRIFFE



SG-48



SG-79



SG-49



SG-83



SG-77

GRIFFSCHALEN



GS-11



GS-21



GS-20



GS-88



GS-74

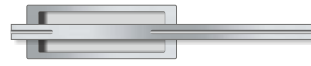

GS-113

V 107  
L=1400 mm



INTEGRIERTE GRIFFLEISTE



J 137 flächenbündig

integrierte Griffleiste - Ral farbe;  
sichtbarer Schlitz = 45mm  
Länge in mm nach Wunsch

TÜRKLOPFER



253 942

Messing- matt verchromt

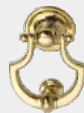

253 944

Messing- poliert schutzlackiert

NAMENSSCHILD



NSE I  
Edelstahl



255 506  
Messing poliert



255 510  
Messing poliert

SICHERHEITS-DRÜCKERGARNITUR



314 866



314 863



316 242



316 668



316 662



316 680

ORNAMENTGLÄSER

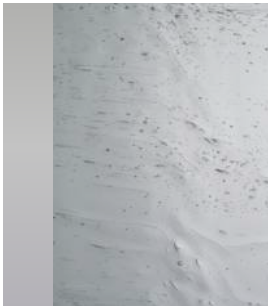

Altddeutsch weiss



Chinchilla weiss

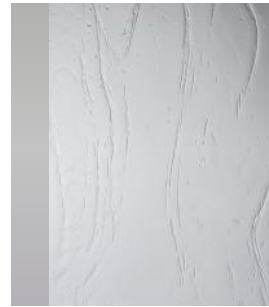

Gothic weiss

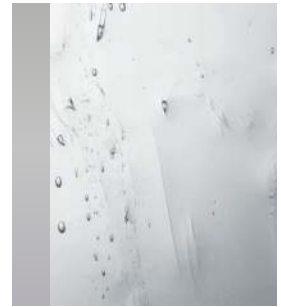

Altddeutsch K weiss

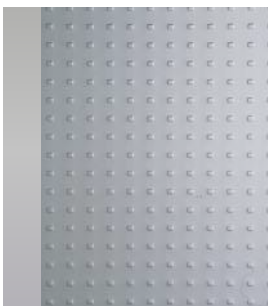

Mastercarre weiss



Masterligne weiss

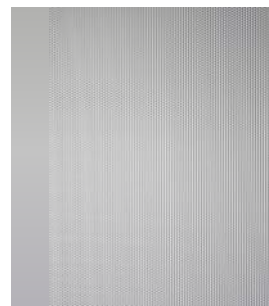

Masterpoint weiss

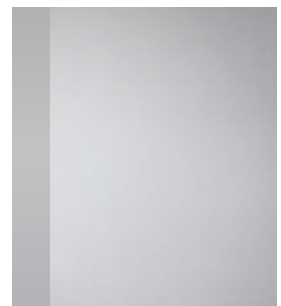

Satinato weiss

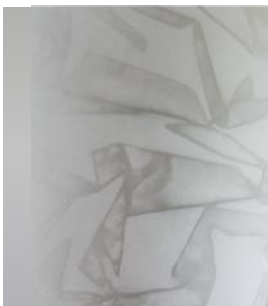

Silk weiss

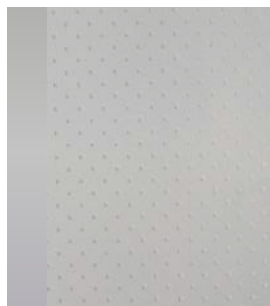

Pave weiss

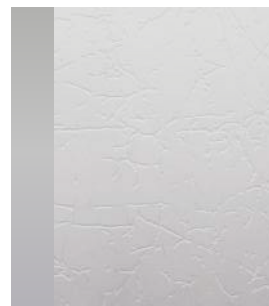

Uadi weiss

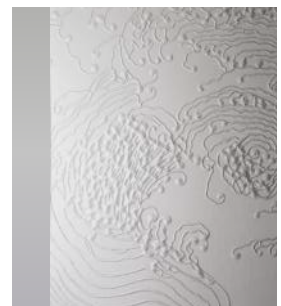

Nebulosa weiss

WÄRMESCHUTZGLAS

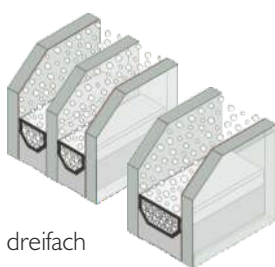

dreifach

zweifach

SANDGESTRAHLTE  
MOTIVE



GLAS MIT  
APPLIKATIONEN



BLEIVERGLASUNG  
MOTIVE



# FARBGESTALTUNGEN

Vielfältige Farbgestaltungen für die Alu-Oberflächen  
Auszug

## MASTER COLLECTION

(feinstruktur, metallic)



Night Grey  
Feinstruktur Metallic



Cast Iron  
Feinstruktur Metallic



Russet Copper  
Feinstruktur Metallic



Brown  
Feinstruktur Metallic



Verdigris  
Feinstruktur Metallic



Granit Nature  
Feinstruktur Metallic



Volcanic Ash  
Feinstruktur Metallic



Elves Bench  
Feinstruktur Metallic

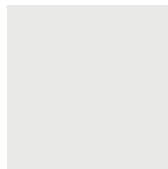

Artic Ice  
Feinstruktur Metallic



Precious Sand  
Feinstruktur Metallic



Iceberg Blue  
Feinstruktur Metallic



Rumbling Sky  
Feinstruktur Metallic

## ANODIZING COLLECTION

(matt, metallic)

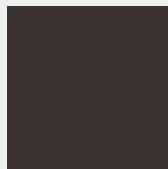

CARBON NIGHT  
Matt Metallic



DARK COPPER  
Matt Metallic



SIMPLY COPPER  
Matt Metallic



GREY BD  
Matt Metallic

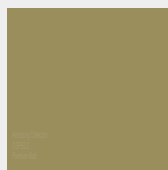

GSPED 2  
Matt



GSPED 3  
Matt



GSPED 4  
Matt

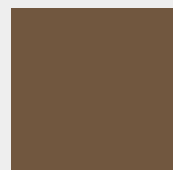

NOBLE BRONZE  
Matt Metallic

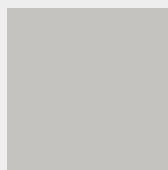

GSPED 0  
Matt



GSPED 1  
Matt



ORIGINAL PLATINIUM  
Matt Metallic

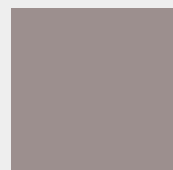

SILVER DREAM  
Matt Metallic

STEINDEKOR

NEU



Dekor Zement hell



Dekor Beton dunkel

HOLZDEKOR

NEU



Dekor Altholz



Dekor Stadelholz grau

RAL FARBEN

(matt, feinstruktur, metallic, glatt)

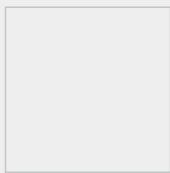

RAL 9016  
Matt/ Feinstruktur

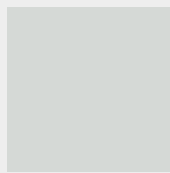

RAL 7035  
Matt/ Feinstruktur

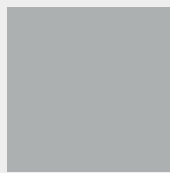

RAL 7004  
Matt/ Feinstruktur



RAL 7016  
Matt/ Feinstruktur

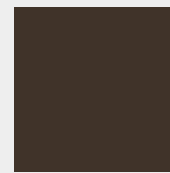

6768 BRAUN  
Feinstruktur

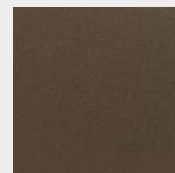

Rostiges eisen  
Feinstruktur

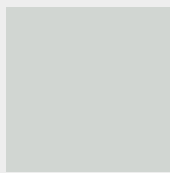

RAL 9006  
Metallic glatt



RAL 9007  
Metallic glatt



DB 703  
Metallic glatt



DB 703  
Metallic Feinstruktur



RAL 8017  
Matt/ Feinstruktur



RAL 5014  
Matt/ Feinstruktur

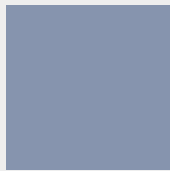

RAL 5014  
Matt/ Feinstruktur

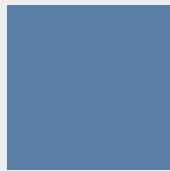

RAL 5007  
Matt/ Feinstruktur

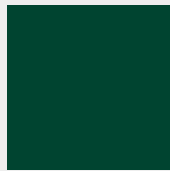

RAL 6005  
Matt/ Feinstruktur



RAL 8001  
Matt/ Feinstruktur

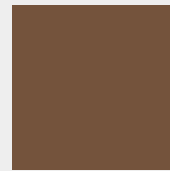

RAL 8003  
Matt/ Feinstruktur

Holzdekor (struktur)



Douglas 2



Douglas 6



Douglas 7

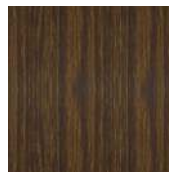

Eiche dunkel



Kirsch 2

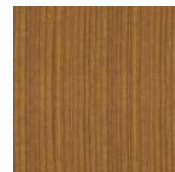

Kirsch 3

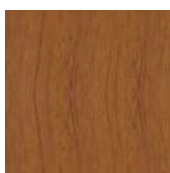

Eiche 4

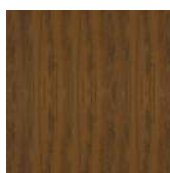

Eiche 2

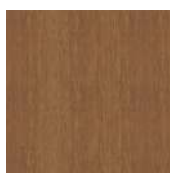

Golden Oak

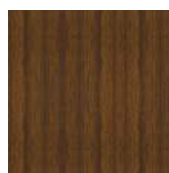

Nuss I

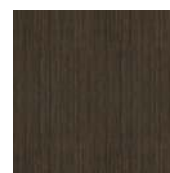

Wenge

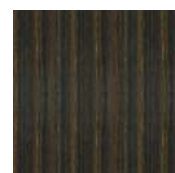

Walnuss dunkel

# ABGEBILDETE TÜREN IN DER ÜBERSICHT

TREND  
AT



AT 100A/AST 100A - Seite 19



AT 101 - Seite 19



AT 102 - Seite 19



AT 100/AST 100A - Seite 8



AT 100 - Seite 7



AT 100 - Seite 7



AT 100 - Seite 9



AT 100/AST 100A - Seite 9



AT 110 - Seite 13



AT 121 - Seite 13



AT 123 - Seite 8



AT 131 - Seite 34



AT 137 - Seite 40



AT 153A - Seite 43



AT 255/AST 255 - Seite 41



AT 258A - Seite 36



AT 264 - Seite 11



AT 264A/AST 264A - Seite 11



AT 265/AST 265 - Seite 10



AT 265A - Seite 10



AT 266 - Seite 12



AT 266A - Seite 12



AT 267 - Seite 40



AT 806/AST 806 - Seite 26



AT 810/AST 100A - Seite 25



AT 843/AST 100A - Seite 28



AT 845/AST 845 - Seite 16



AT 862A/AST 862A - Seite 21



AT 863A/AST 863A - Seite 32



AT 863B - Seite 32



AT 863C - Seite 33



AT 864/AST 864 - Seite 37



AT 866B/AST 866B - Seite 29



AT 867 - Seite 18



AT 867/AST 867 - Seite 18



AT 872 - Seite 28



AT 875A - Seite 34



AT 875B - Seite 35



AT 881A - Seite 43



AT 883/AST 883 - Seite 43



AT 885 - Seite 42



AT 885A/AST 885A - Seite 42



AT 887 - Seite 44



AT 887B - Seite 45

## ABGEBILDETE TÜREN IN DER ÜBERSICHT



AT 887D - Seite 44



AT 887E/AST 887E - Seite 45



AT 889A - Seite 41



AT 891 - Seite 37



AT 891A - Seite 37



AT 893 - Seite 36



AT 894 - Seite 23



AT 901 - Seite 29



AT 904 - Seite 39



AT 906 - Seite 20



AT 906A - Seite 21



AT 907 - Seite 17



AT 907A - Seite 15



AT 907B - Seite 15



AT 909/AST 909 - Seite 24



AT 911/AST 911 - Seite 17



AT 919 - Seite 16



AT 920 - Seite 23



AT 924A/AST 924A - Seite 27

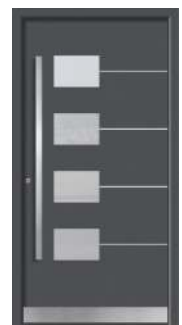

AT 934 - Seite 31



AT 934A - Seite 31



AT 941A - Seite 20



AT 943 - Seite 39



AT 944 - Seite 25



AT 945A - Seite 24





AT 946A- Seite 26



AT 946B - Seite 27



AT 947/AST 947 - Seite 33



AT 948/AST 948 - Seite 35

DELUXE  
AD



AD 168/AST 168 - Seite 51



AD 801A/AST 801 - Seite 49



AD 802A - Seite 50



AD 843A - Seite 47



AD 852A - Seite 49



AD 863D - Seite 47



AD 875C - Seite 50



AD 923 - Seite 51



AD 945 - Seite 48



AD 945A/AST 945 - Seite 48

MODERN  
AM



AM 131 - Seite 56



AM 132A - Seite 54



AM 133A - Seite 57



AM 134B - Seite 55



AM 156 - Seite 57



AM 170 - Seite 58



AM 172C - Seite 55



AM 180 - Seite 59

## ABGEBILDETE TÜREN IN DER ÜBERSICHT



AM 181 - Seite 58



AM 222 - Seite 59



AM 863D - Seite 53



AM 863D - Seite 53



AM 875C - Seite 56



AM 945A- Seite 54

CLASSIC  
AC

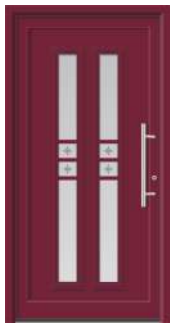

AC 173



AC 178



AC 182 - Seite 61



AC 182A - Seite 62



AC 183 - Seite 65



AC 184 - Seite 62



AC 185/AST 185 - Seite 63



AC 186 - Seite 63



AC 188



AC 190



AC 190A/AST 190 - Seite 65



AC 191/AST 191 - Seite 64



AC 192 - Seite 64



AC 194



AC 194A - Seite 66



AC 195



AC 195A - Seite 67



AC 198



AC 201



AC 202/AST 202



AC 203A - Seite 65



AC 206 - Seite 66



AC 207 - Seite 61



AC 208



AC 209



AC 209A - Seite 67



AC 210



AC 213



AC 218



AC 545

Aufgrund drucktechnischer Gegebenheiten können Farbabweichungen zwischen den Darstellungen in diesem Prospekt und den Original-Produkten auftreten.

Technische Änderungen, Satz- und Druckerfehler vorbehalten.

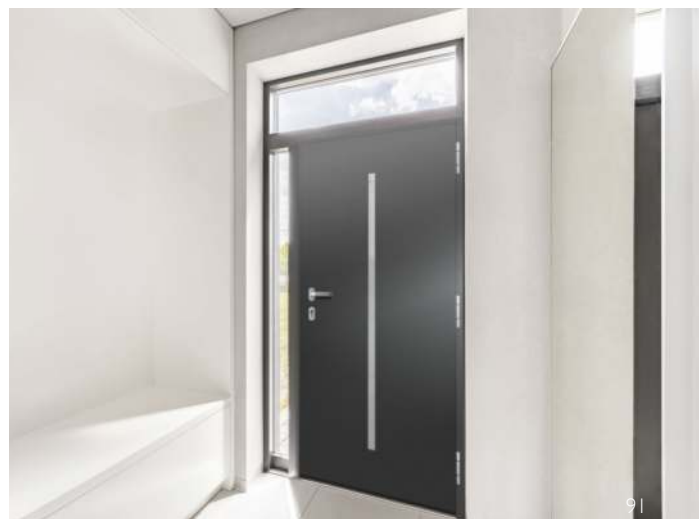

[www.isarholz.com](http://www.isarholz.com)

Wir freuen uns, Sie  
persönlich zu beraten

